

LabVIEW PROFIBUS VISA Driver DP-Master

Getting Started

V1.35

27.04.2017

Project No.: 5303
Doc-ID.: LabVIEW PROFIBUS VISA Driver

Revision History

Version	Date	Description
V1.35	27.04.2017	Minor Changes
V1.34	31.03.2017	KUNBUS Branding
V1.33	16.02.2011	Function Palette location changed
V1.32	09.09.2009	Hot plugging note added
V1.31	02.06.2009	Minor Fixes
V1.30	16.11.2007	RT Installation changed
V1.29	25.09.2007	DPV1 added
V1.23	03.08.2006	Configurator III Download and Monitor/Modify
V1.22	17.07.2006	Link to Configurator III changed
V1.21	13.01.2006	Download tool upgrade
V1.2	28.07.2005	Driver modification / Example update
V1.1	01.06.2005	Express-VI modification / VI-Library update
V1.0	14.12.2004	Initial Version

KUNBUS GmbH
Heerweg 15c
73770 Denkendorf, Germany
Phone +49 711 300 20 678
Fax +49 711 300 20 677

Copyright © 2017 by **KUNBUS** GmbH

This document is protected by copyright. Reproduction, duplication, publishing, transfer or disclosure of the contents of this document are only permitted after prior written agreement has been obtained from **KUNBUS** GmbH.

Contents

1	Introduction.....	1
1.1	Prerequisites:.....	1
2	Installation	1
3	PROFIBUS-DP configuration	3
3.1	PROFIBUS-DP configuration download.....	4
3.2	Configurator III Monitor/Modify mode	6
4	PROFIBUS-DP menu and example	7
4.1	PROFIBUS-DP-Master menu	7
4.2	PROFIBUS-DP-Master example	9
5	PROFIBUS-DP-Master Express VI	10
6	PROFIBUS-DPV1.....	13
6.1	Stand alone operation of the DF PROFI II board as DP Master Class 2	13
6.2	Initiate_Req	14
6.3	Read_Req	15
6.4	Write_Req.....	17
6.5	Abort_Req	18

List of Figures

Figure 1: Driver installation	1
Figure 2: Driver directory.....	2
Figure 3: Measurement and Automation explorer.....	2
Figure 4: KUNBUS Configurator III.....	3
Figure 5: PROFIBUS-DP-Master menu.....	7
Figure 6: PROFIBUS-DPV1 Services menu.....	7
Figure 7: PROFIBUS-DP-Master Express menu	8
Figure 8: PROFIBUS-DP-Master example front panel.....	9
Figure 9: PROFIBUS-DP-Master example block diagram	9
Figure 10: DP-Master Express PROFIBUS	10
Figure 11: DP-Master Express Monitor/Modify	11
Figure 12: DP-Master Express Diagnostic.....	12
Figure 13: DP-Master Express VI.....	12
Figure 14: DPV1 Initiate_Req front panel	14
Figure 15: DPV1 Read_Req front panel.....	15
Figure 16: DPV1 Read_Req Success Tab front panel.....	16
Figure 17: DPV1 Write_Req front panel	17
Figure 18: DPV1 Abort_Req front panel.....	18

1 Introduction

This document describes the set into operation procedure of the DF PROFI II board as DP-Master.

1.1 Prerequisites:

- A DF PROFI II and **KUNBUS** LabVIEW VISA driver for Windows 2000/XP on CD.
- The National Instruments LabVIEW Development System installed on the Windows PC.
- Installed NI-VISA standard driver on the Windows-System.

2 Installation

- Install the DF PROFI II board in the PC-System.

Please note, if a DF PROFI II CPCI board is used, the board does not support Hot Plugging. If installing/uninstalling the board the Compact PCI system must be switched off and the power supply must be interrupted.

- Switch on the PC-System.
- Start the Setup from the **KUNBUS** driver CD delivered with the package.
- Install the board driver software via the Windows “New hardware”- dialog which is popped up automatically after the board was installed. Select the option to install the driver from the specify directory:



Figure 1: Driver installation

- Select the install directory of the driver software:

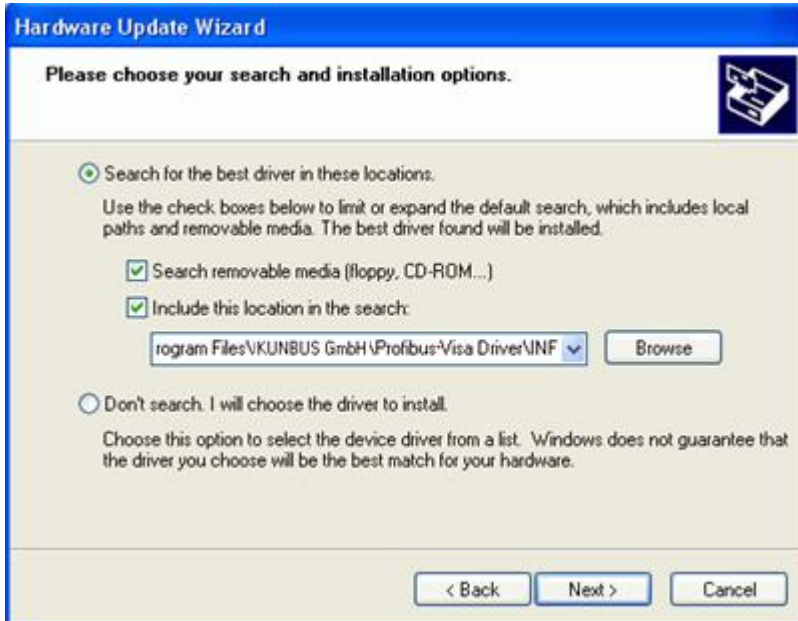

Figure 2: Driver directory

- Check by the NI MAX (Measurement & Automation explorer) the proper installation of the DF PROFI II board:

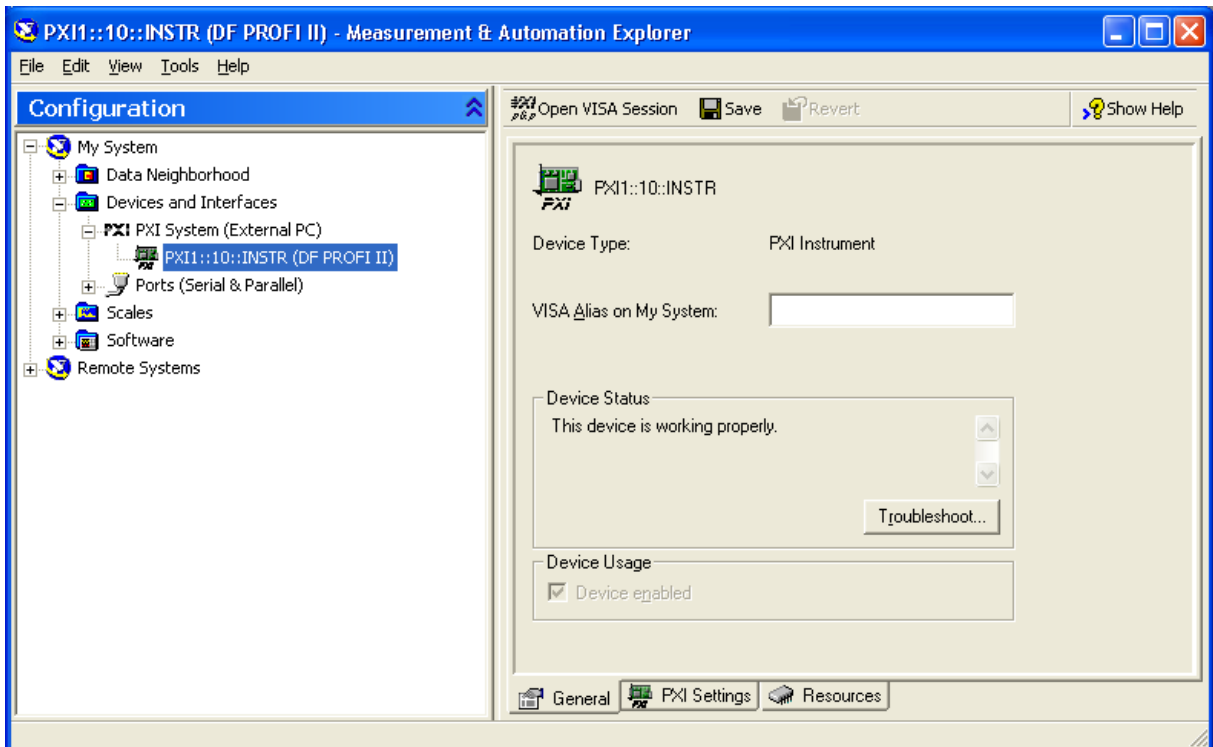

Figure 3: Measurement and Automation explorer

3 PROFIBUS-DP configuration

The PROFIBUS-DP configuration is carried out by the **KUNBUS** PROFIBUS-DP configuration tool Configurator II.

- Start Configurator III from the KUNBUS GmbH / Profibus Configurator / Configurator III menu. Configurator III allows to create the complete PROFIBUS-DP configuration based on DP-Slave GSD-Files. Refer to the on line help menu for all details.
- Create and save the configuration.

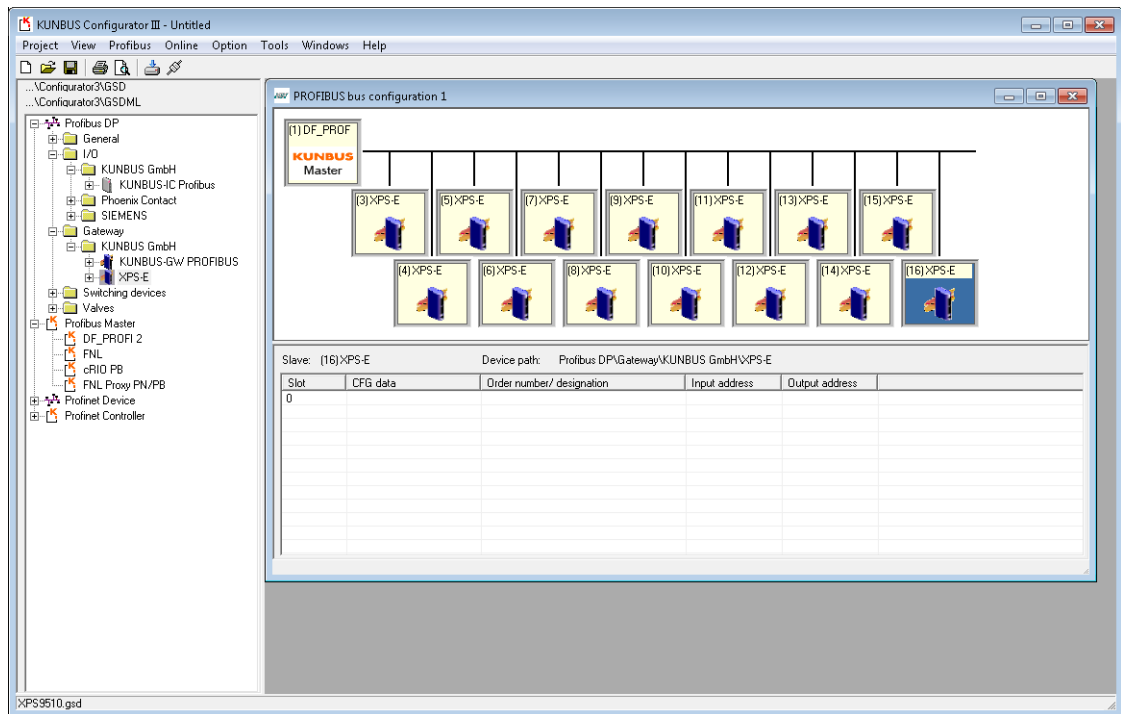

Figure 4: KUNBUS Configurator III

3.1 PROFIBUS-DP configuration download

Configurator III provides an integrated download function to flash the PROFIBUS-DP Configuration on the DF PROFI II board.

Proceed the following steps:

- **Select a DFPROFI II VISA board from the Online – Menu:**

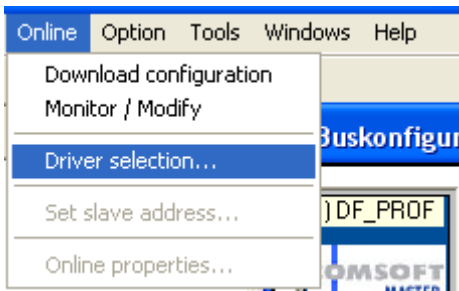

The installed DF PROFI II boards are displayed:

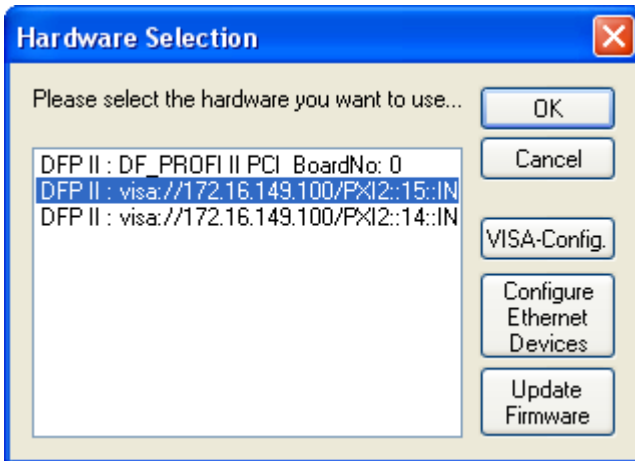

Select a DF PROFI II board and click the OK button. If nothing is displayed click the VISA-Config. button to rescan the available DF PROFI II VISA boards.

Refer to the online help system of Configurator III for details of the driver selection.

- **Download the PROFIBUS-DP configuration**

Click the Download Symbol in the tool bar of Configurator III :

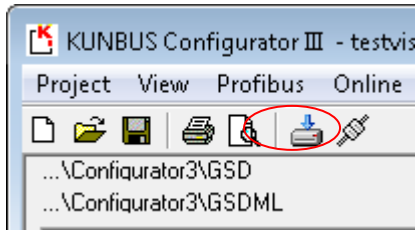

The PROFIBUS-DP configuration is downloaded to the DF PROFI II board:

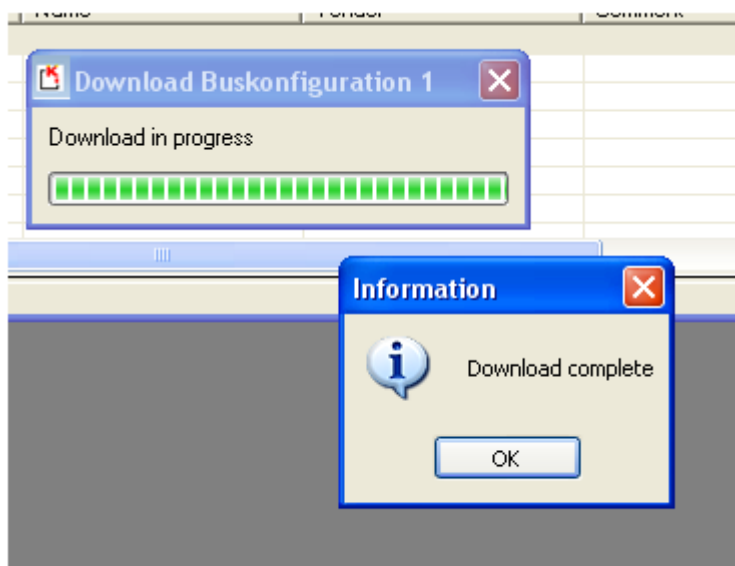

3.2 Configurator III Monitor/Modify mode

With the Monitor/Modify mode of the Configurator III the flashed PROFIBUS-DP configuration can be tested immediately. Please note that the configured DP-Slaves must be connected to the DF PROFI II board.

Click the Monitor/Modify symbol of the Toolbar of Configurator II:

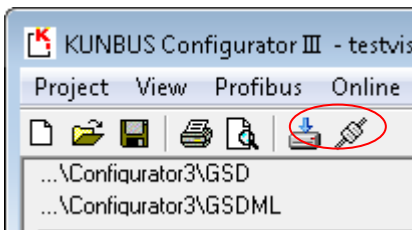

Configurator III displays the PROFIBUS-Network in Online mode:

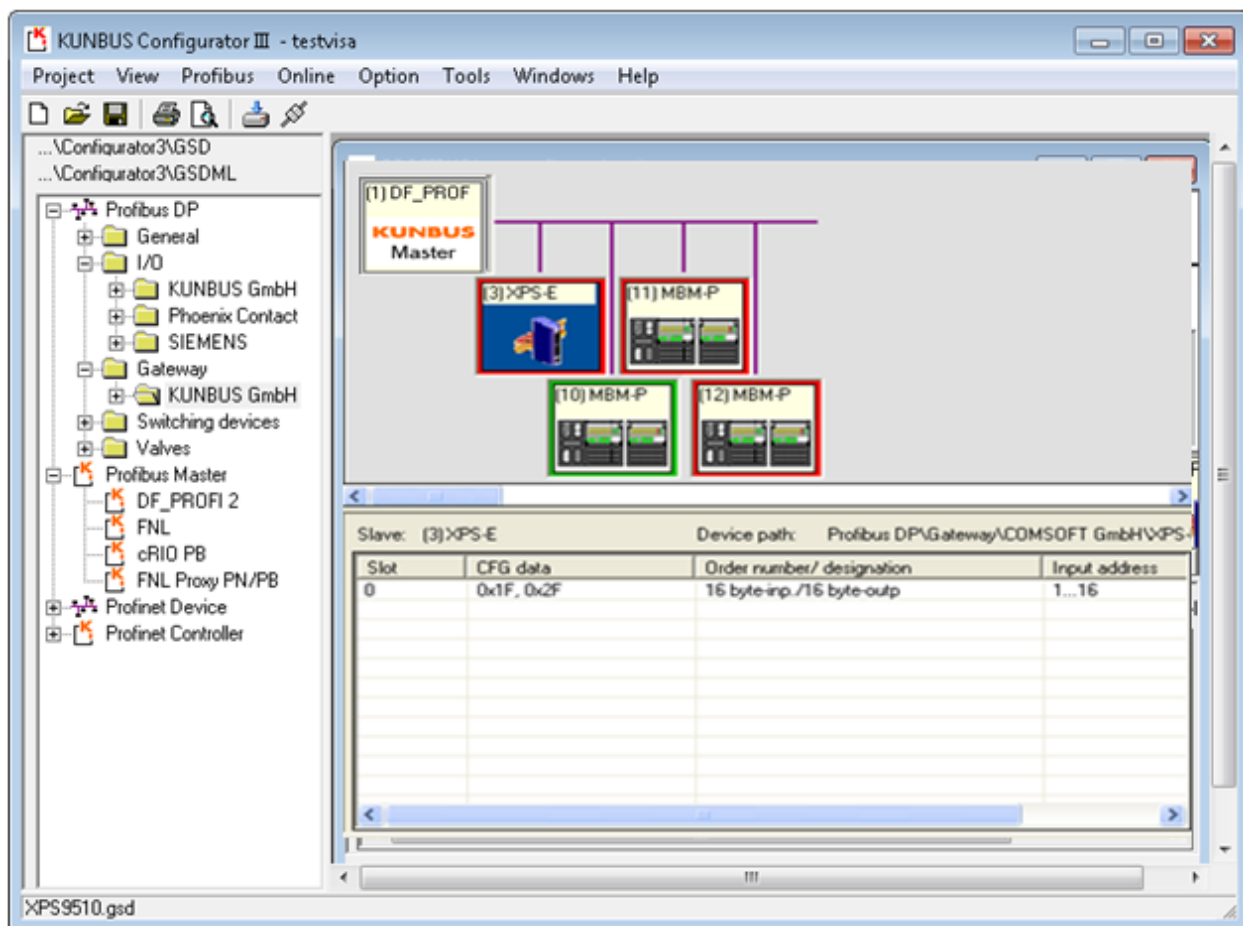

Configurator III displays the status of every DP-Slave (coloured frame) and allows to monitor and modify the I/O data by clicking the DP-Slaves. For further details please refer to the online help system of Configurator II.

4 PROFIBUS-DP menu and example

The delivery package includes standard VIs to initialize the PROFIBUS and to access the DP-Slaves I/O and diagnostic data. For a successful communication see the PROFIBUS example program. Refer to the LabVIEW Context Help for details.

4.1 PROFIBUS-DP-Master menu

The **KUNBUS** DF PROFI II menu is located in:

- KUNBUS Library

- PROFIBUS VISA Driver



- DF PROFI II DP-Master

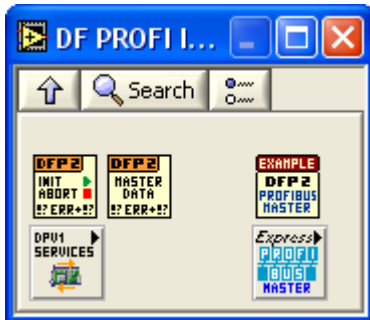



Figure 5: PROFIBUS-DP-Master menu

- DF PROFI II DPV1 Services



Figure 6: PROFIBUS-DPV1 Services menu

For an easy access to a single DP-Slave a DP-Master Express VI is available. The Express VI can be found in the **KUNBUS** DF PROFI II menu under:

- DP-Master Express 

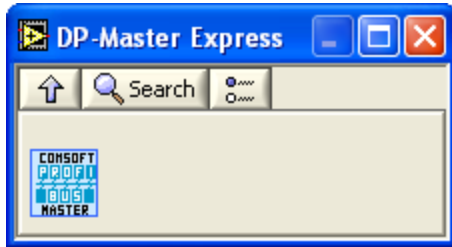

Figure 7: PROFIBUS-DP-Master Express menu

4.2 PROFIBUS-DP-Master example

The DFP2_DP-MasterExample program shows all configured DP-Slaves, their communication state, the I/O-data and the diagnostic data:

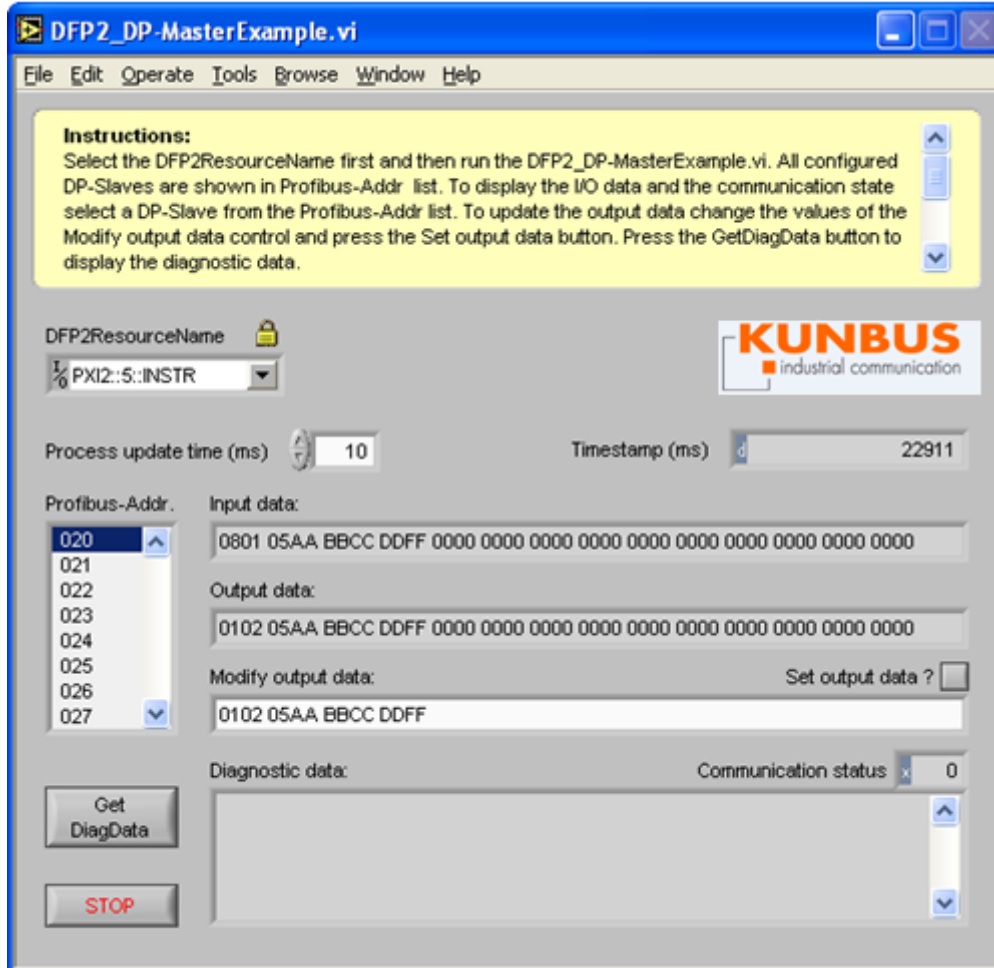

Figure 8: PROFIBUS-DP-Master example front panel

The VIs block diagram shows the simple steps how to access the DP-Slaves.

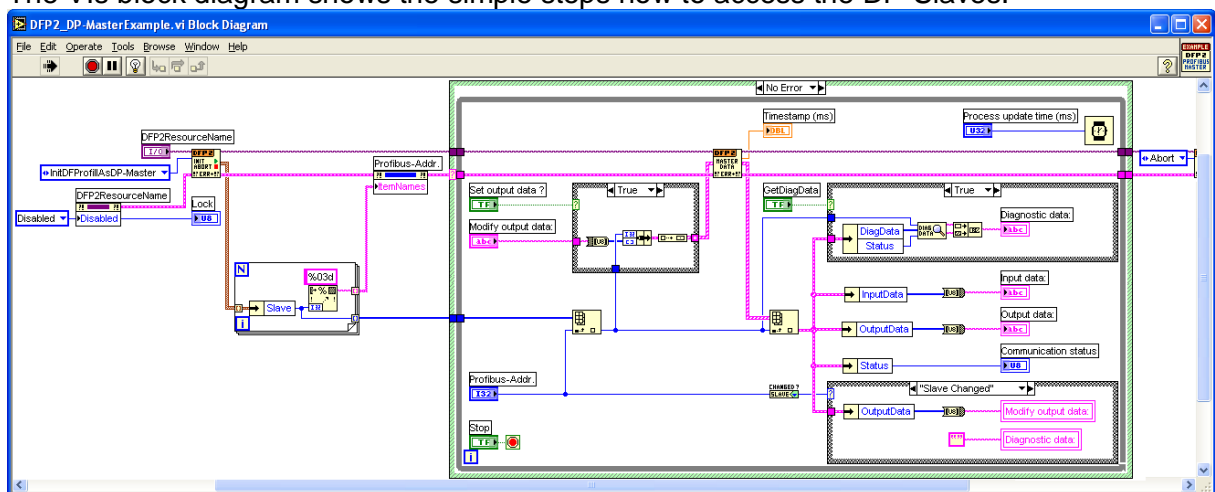

Figure 9: PROFIBUS-DP-Master example block diagram

5 PROFIBUS-DP-Master Express VI



For an easy access to a single DP-Slave a PROFIBUS-DP-Master Express VI is available. If dropping the Express-VI to the block diagram a configuration dialog opens to enter the DF PROFI II board and the PROFIBUS address of the DP-Slave:

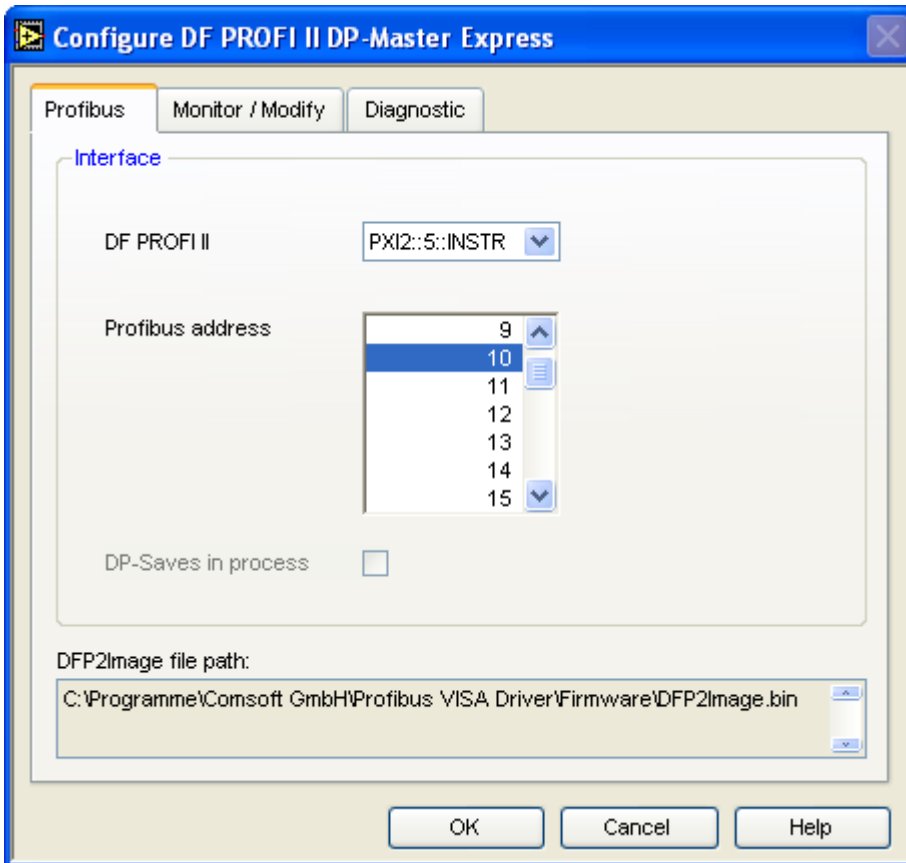

Figure 10: DP-Master Express PROFIBUS

The Monitor/Modify-Tab shows the input and output data as well as the communication status of the DP-Slave. The output data can be modified by clicking directly in the value field and entering new data. The data must be entered in the same format as displayed, otherwise they will be ignored:

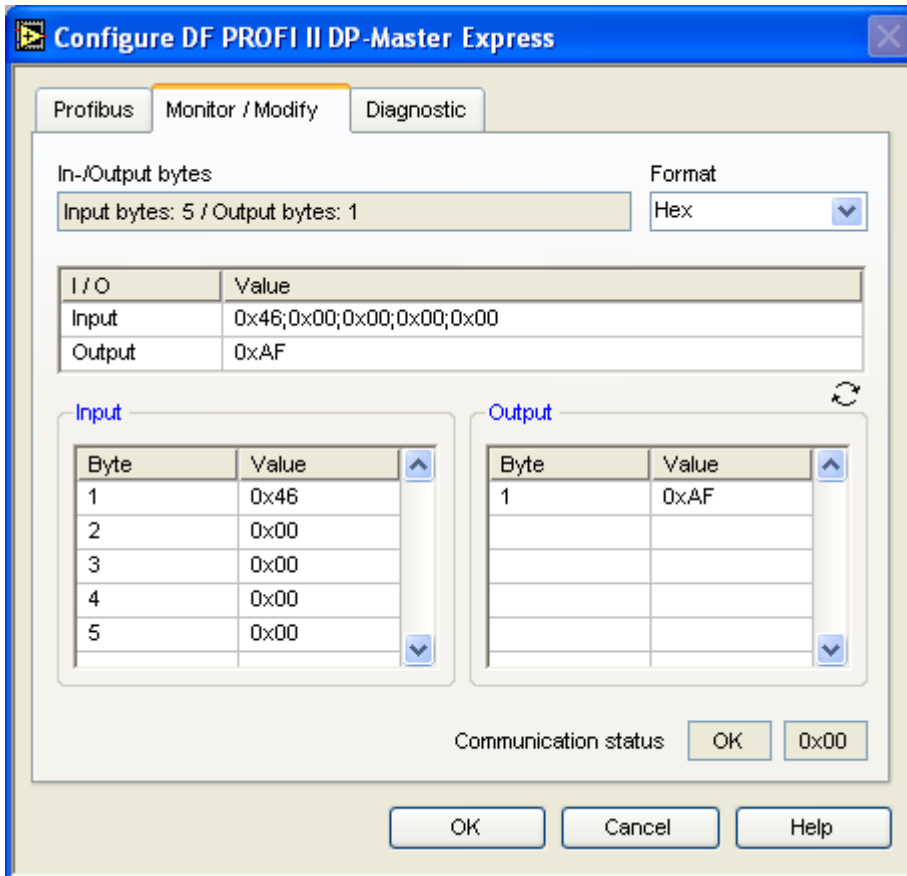

Figure 11: DP-Master Express Monitor/Modify

Note: Before using the monitor/modify-mode a available DF PROFI II and a valid PROFIBUS address must be selected.

The Diagnostic-Tab shows the diagnostic data transmitted by the DP-Slave. The data are displayed in clear text for the standard PROFIBUS diagnostic data and in hexadecimal format for the extended diagnostic data:

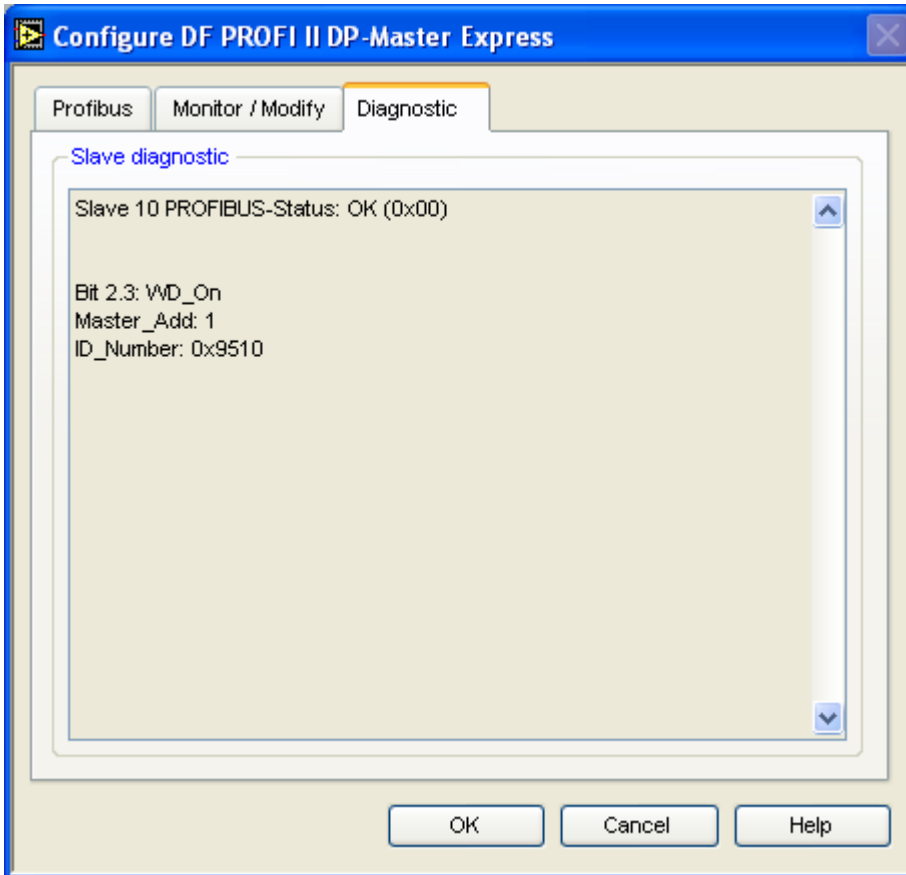

Figure 12: DP-Master Express Diagnostic

After configuration the PROFIBUS Express VI provides all necessary DP-Slave data:

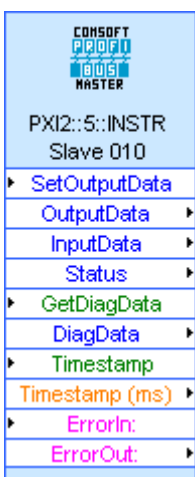

Figure 13: DP-Master Express VI

To change the properties double click the Express VI

6 PROFIBUS-DPV1

To access the DPV1 variables of a DP Slave the DF PROFI II board supports the acyclic DPV1 protocol as Master Class 2. To exchange acyclic data with a DP Slave the following steps are necessary:

- Start the cyclic data traffic with the DP Slaves
- Establish a DPV1 connection to the DP Slave (Initiate_Req)
- Read or Write acyclic DPV1 data (Read_req, Write_Req)
- Abort the DPV1 connection to the DP Slave

For the DPV1 data structure of the DP Slave refer to users guide of the DP Slave.

6.1 Stand alone operation of the DF PROFI II board as DP Master Class 2

The actual version of the PROFIBUS VISA driver board does still not support a stand alone operation as DPV1 Master Class 2. If the DF PROFI II board shall be used as DPV1 Master Class II a DPV0 configuration must be downloaded storing the correct DP Master configuration with one dummy DP Slave that is not existent.

6.2 Initiate_Req

Establishes a DPV1 connection to the DP Slave.

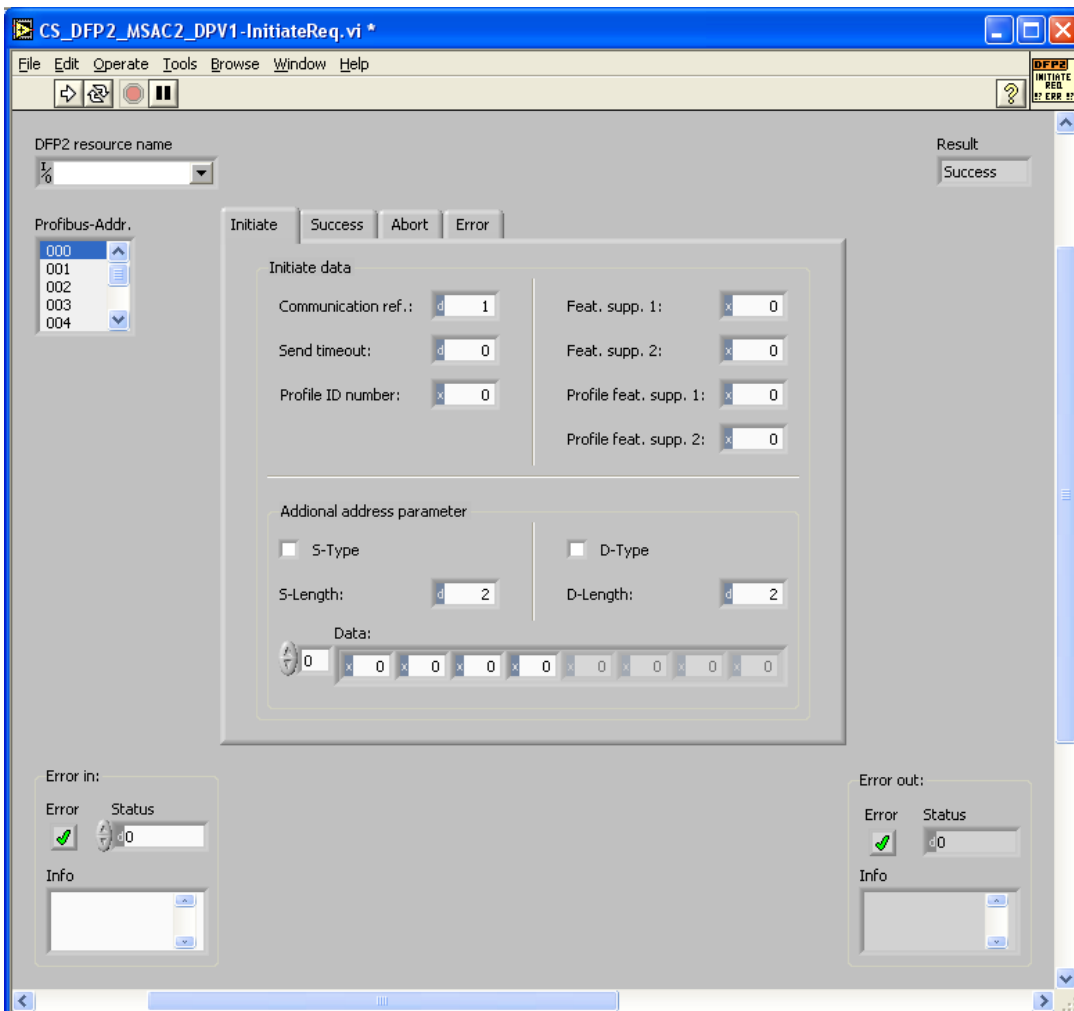

Figure 14: DPV1 Initiate_Req front panel

- Select the DFP2 resource name and the PROFIBUS address of the DP Slave.
- Enter the value **1000** for the parameter **Send timeout**. Send timeout sets the internal timers for the connection monitoring and the response timeout. The Send timeout value is assigned in multiples of **10 mS**, 1000 means 10000 mS or 10 s.
- Leave all other parameters unchanged.
- Run the VI. After the VI terminated, the status value in the Error out block must be set to a value of 87, what means that the DPV1 connection was successfully established to the DP Slave.

6.3 Read_Req

Reads a variable of a DP Slave DPV1.

The DPV1 variables of a DP Slave are selected by the parameters **Slot number** and **Index**. Refer to the documentation of the DP Slave for a detailed description of all available variables.

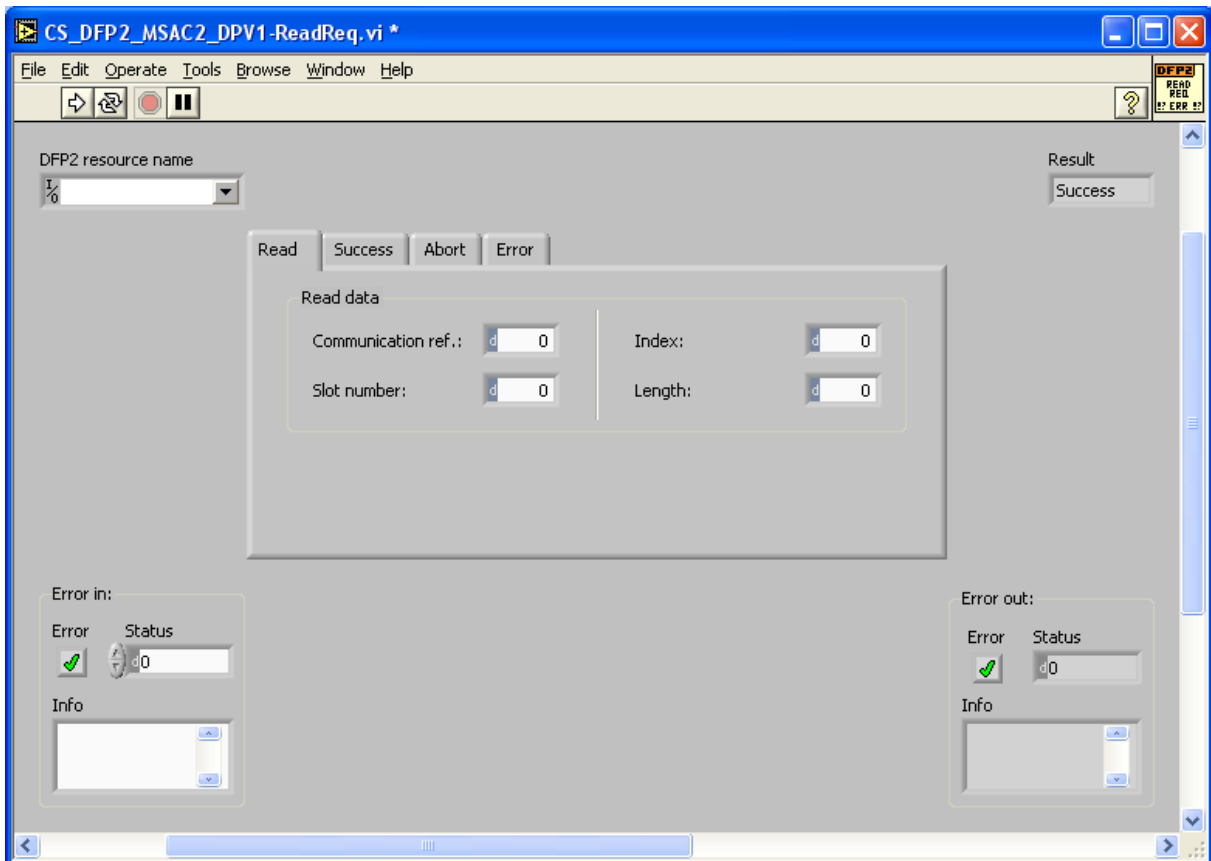

Figure 15: DPV1 Read_Req front panel

- Select the DFP2 resource name.
- Enter the identical value (1) for **Communication ref** as used for Initiate_Req.
- Enter the **Slot Number**, **Index** and **Length** for the DPV1 variable to be read. To enter the DP Slave address is not necessary, this is decoded via the **Communication ref** parameter, which was assigned as 1 during connection setup.
- Run the VI. After the VI has terminated, the status value in the ErrorOut block must be set to a value of 94, what means that Data have been successfully read from the DP Slave.

- If you check the Data section in the **Success** tab the data read from the DP Slave are displayed.

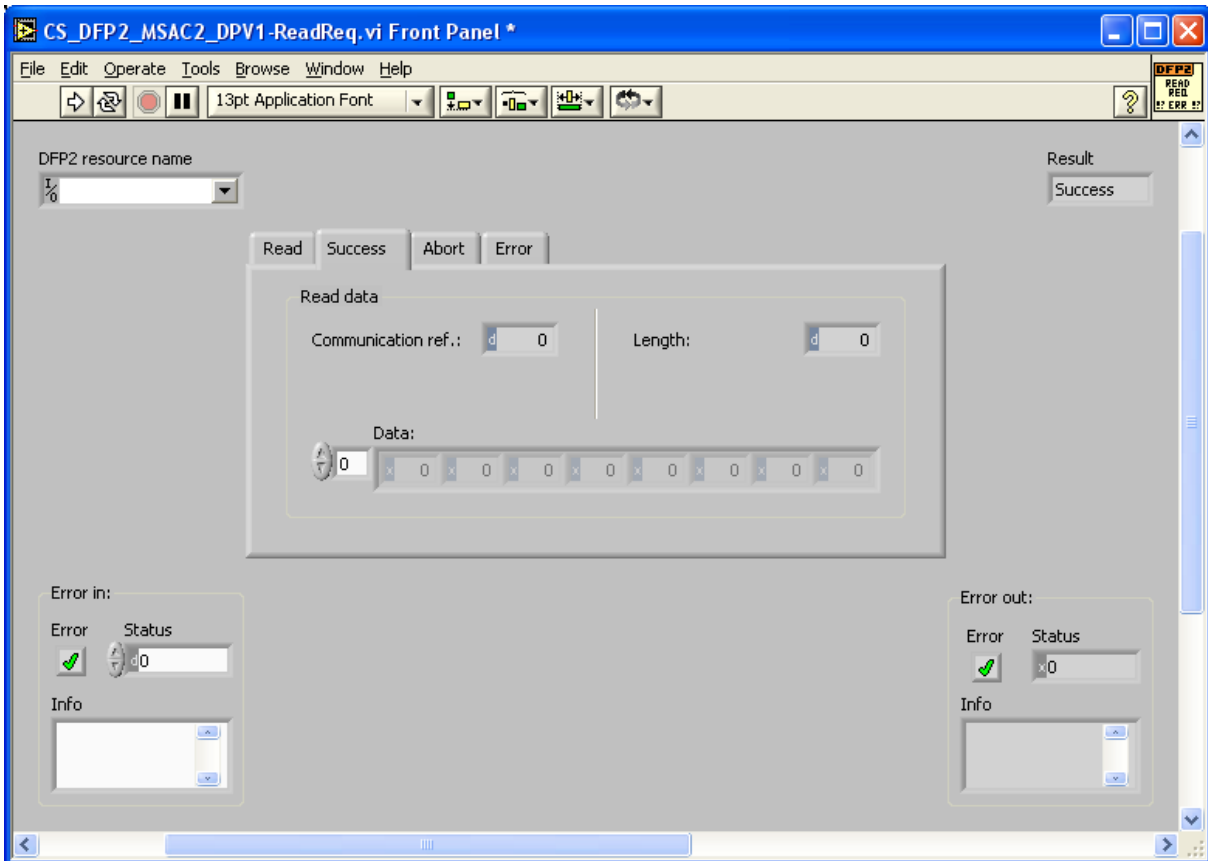

Figure 16: DPV1 Read_Req Success Tab front panel

6.4 Write_Req

Writes a variable to a DP Slave DPV1.

The DPV1 variables of a DP Slave are selected by the parameters **Slot number** and **Index**. Refer to the DP Slave's documentation for a detailed description of all available DPV1 variables.

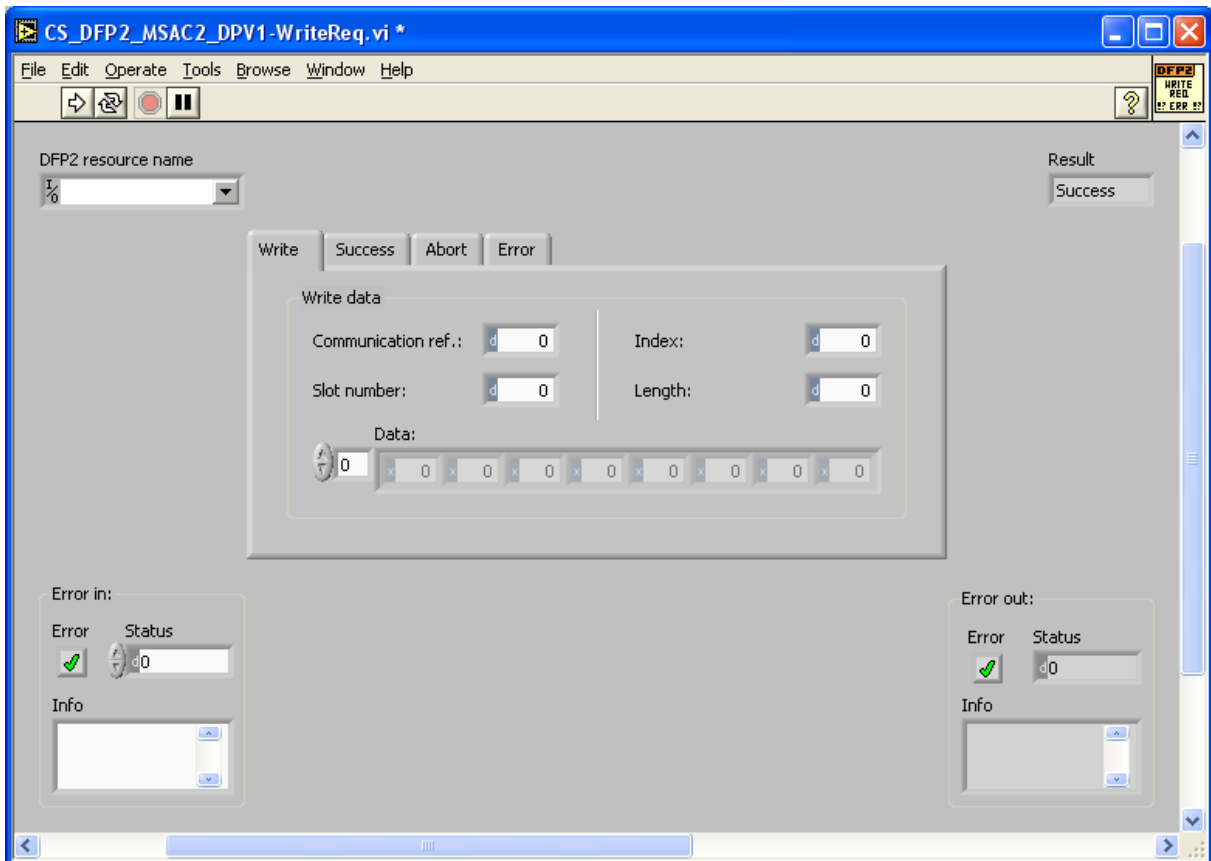

Figure 17: DPV1 Write_Req front panel

- Select the DFP2 resource name.
- Enter the identical value (1) for **Communication ref** as used for Initiate_Req.
- Enter the **Slot Number**, **Index** and **Length** for the DPV1 variable to be written. To enter the DP Slave address is not necessary, this is decoded via the **Communication ref** parameter, which was assigned as 1 during connection setup.
- Enter the data to be written in the **Data** field. The length is automatically adjusted according to the entered data.
- Run the VI. After the VI has terminated, the status value in the Error out block must be set to a value of 95, what means that Data have been successfully written to the DP Slave.

6.5 Abort_Req

Terminates the connection with a DP Slave.

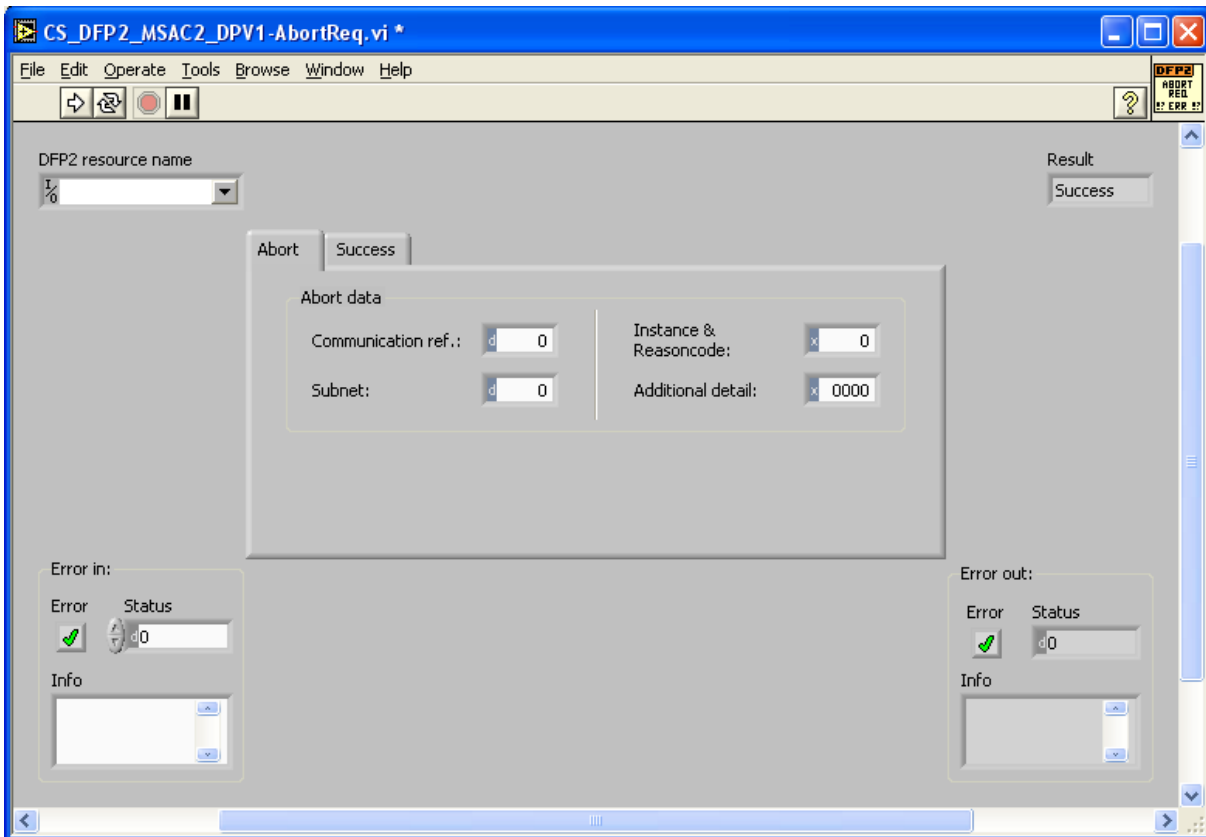

Figure 18: DPV1 Abort_Req front panel

- Select the DFP2 resource name.
- Enter the identical value (1) for **Communication ref** as used for Initiate_Req. To enter the DP Slave address is not necessary, this is decoded via the **Communication ref** parameter, which was assigned as 1 during connection setup.
- Leave all other parameters unchanged.
- Run the VI. After the VI has terminated, the status value in the ErrorOut block must be set to a value of 130, what means that the DP Slave is successfully disconnected.